



DSCPUMPS SRL  
DOSING FILTER AND STORAGE

# DSCPUMPS

WATER FOUNTAIN

COUNTERTOP

UNDERSINK

BUILT-IN

HO.RE.CA.

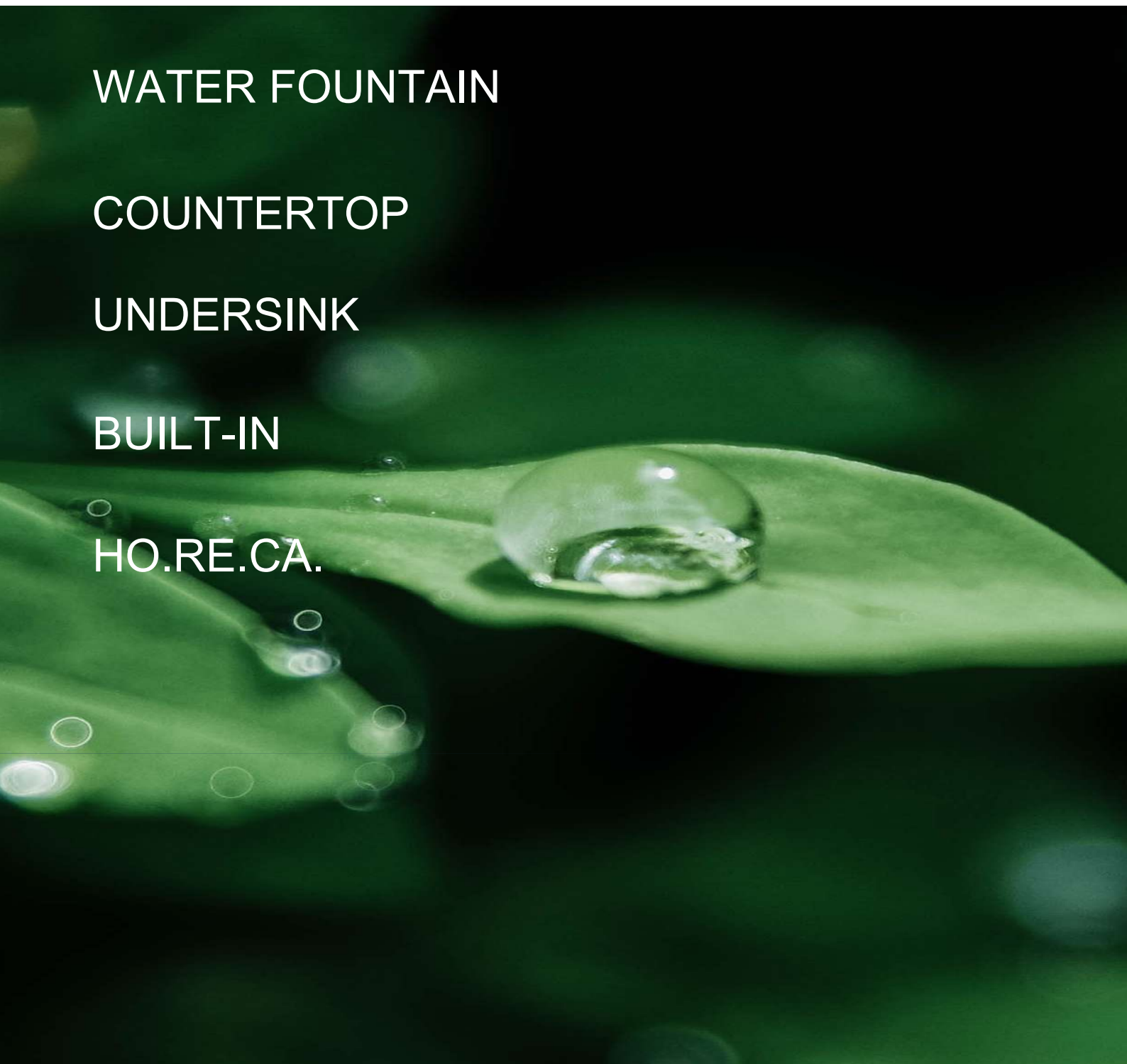

[WWW.DSCPUMPS.IT](http://WWW.DSCPUMPS.IT)

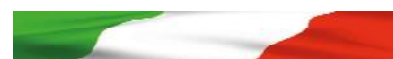

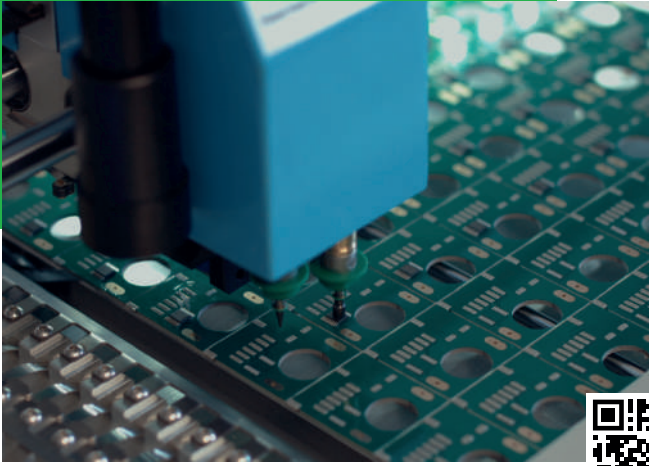

















**Ogni impianto è un biglietto da visita,  
una lunga storia da raccontare  
fra tradizione e innovazione.  
Soluzioni uniche al mondo per garantire  
la qualità più alta di sempre.**

*Every product is our business card,  
a potent mix of tradition and innovation  
that we have been perfecting for decades.  
Unique solutions of the highest quality. Always.*

# **SOMMARIO/Summary**

|  |  |           |
|--|--|-----------|
|    | <b>TECNOLOGIE ESCLUSIVE - <i>Exclusive technologies</i></b>                  | <b>4</b>  |
|    | <b>SOLUZIONI PER OGNI SETTORE - <i>Destination everywhere</i></b>            | <b>5</b>  |
|    | <b>FONTANE - <i>Water fountain</i></b>                                       | <b>6</b>  |
|    | <b>POU - <i>Point of use</i></b>   | <b>8</b>  |
|    | <b>SOPRALAVELLI - <i>Countertop</i></b>                                      | <b>10</b> |
|  | <b>SOTTOLAVELLI - <i>Undersink</i></b>                                       | <b>14</b> |
|  | <b>DA INCASSO - <i>Built-in</i></b>  | <b>18</b> |
|  | <b>HO.RE.CA.</b>   | <b>20</b> |
|  | <b>KOLUMNA TOUCH</b>   | <b>30</b> |
|  | <b>ARE YOU FRISKA?</b>   | <b>32</b> |
|  | <b>FILTRAZIONE - <i>Filtration</i></b>                                       | <b>35</b> |
|  | <b>RUBINETTI - <i>Taps</i></b>   | <b>36</b> |
|  | <b>ACCESSORI PER CO<sub>2</sub> - <i>CO<sub>2</sub> accessories</i></b>      | <b>37</b> |
|  | <b>KIT</b>   | <b>38</b> |
|  | <b>ACCESSORI &amp; MERCHANDISING- <i>Accessories &amp; merchandising</i></b> | <b>39</b> |
|  | <b>LOGISTICA - <i>Logistic</i></b>   | <b>40</b> |
|  | <b>GARANZIA - <i>Warranty</i></b>  | <b>41</b> |

## TECNOLOGIE ESCLUSIVE/EXCLUSIVE TECHNOLOGIES



### HIGH PERFORMANCE DIRECT CHILL

L'unico sistema in grado di raffreddare l'acqua in soli 3' con un consumo inferiore a 7 Kw/h.

*Patented cooling system. Cools water in just 3 mins, using less than 7 kw/h.*



### CU+ HYGIENE

Serpentine in rame

batteriostatico certificato per un'igiene senza confronti.  
*Certified bacteriostatic copper for the highest hygiene levels.*



### SILVER TURBO CLEAN

Esclusivo sistema ermetico di raffreddamento in acciaio inox con saldature in argento batteriostatico.

*Exclusive hermetically sealed stainless steel cooling system welded together with antibacterial silver. A water vortex prevents biofilm formation.*



### DIRECT CHILL

Vasca a banco di ghiaccio per l'erogazione di acqua refrigerata in continuo per impianti professionali.

*Ice bank tank for a reliable, continuous supply of chilled water.*



### NO SANITIZE

Nessuna sanificazione periodica: igiene garantita e costi di manutenzione ridotti.

*Saves time and money as periodical sanitising not required.*



### DRINK QUALITY

Componentistica certificata per eliminare ogni possibilità di contaminazione dei materiali.

*Only food contact certified components used. Maximum attention to detail in assembly meaning zero possibility of contamination.*



### SAHARA CLIMA

Permette l'utilizzo dell'impianto con temperatura esterna fino a 43 °C.

*Proprietary technology enables units to function perfectly with external temperatures of up to 43 °C.*



### CLASSE A+++

La migliore in termini di efficienza energetica.

Alte prestazioni e consumi contenuti.

*The most efficient energy rating guaranteeing incredibly low energy consumption.*



### LOW NOISE

Impianti progettati per funzionare a bassi livelli di rumorosità.

*Units designed to be as quiet as possible.*



### SODA SYSTEM

Sistema professionale per l'erogazione di grandi quantità di acqua frizzante con livello di CO<sub>2</sub> regolabile.

*Professional-standard system for supplying large quantities of sparkling water with easily adjustable CO<sub>2</sub> levels.*



### TOUCH SCREEN

Display interattivo con interfaccia user friendly per la gestione e il monitoraggio delle modalità di erogazione e porzionatura volumetrica.

*User-friendly interactive touchscreen with videos, alerts and real-time metrics.*



### AUXILIA IoT

Sistema di telemetria per la gestione e il monitoraggio dei parametri tecnici: accesso remoto da pc, tablet o smartphone.

*Real-time remote management and monitoring over the internet from your PC, tablet or smartphone. Telemetry used to display technical metrics.*



### PAY & DRINK

Possibilità di acquisto tramite applicazione mobile per dispositivi Android.

*Purchase drinks using a mobile app (Android devices).*



### NFC

Sistema di pagamento contactless tramite chip NFC integrato.

*Contactless payment system via integrated NFC reader.*



### DRYSAFE

Trattamento a secco del circuito idrico contro la proliferazione batterica.

*Dry treatment of the water circuit against bacterial proliferation.*

# SOLUZIONI PER OGNI SETTORE/DESTINATION EVERYWHERE



Domestic

Public spaces



Pubs & bars

Vending



Ho.Re.Ca.

## LEGENDA/LEGEND



ACQUA FREDDA/CHILLED WATER



ACQUA CALDA/HOT WATER



ACQUA AMBIENTE/AMBIENT WATER



UTENZA/USERS



ACQUA FRIZZANTE/SPARKLING WATER

# FONTANE/WATER FOUNTAIN



**Lo stile delle intramontabili fontanelle in un concentrato di tecnologie esclusive per una gamma di refrigeratori unica al mondo.**

*The timelessly classic water fountain design unexpectedly brimming with exclusive technologies makes this range totally unique.*



**Anti Covid-19 solution**



*Pedale/Foot control (optional)*

**REFRESH®P 240/260**  
**REFRESH® Pensile 260**

**“Il primo della classe**  
*Hardworking, top of the class”*





20 - 30

## Refresh® P 240/260 - Refresh® Pensile 260

| Mod.                              | Cod.         |   | Power** | l/h     | Dispensing                | Technology                |
|-----------------------------------|--------------|---|---------|---------|---------------------------|---------------------------|
| <b>P ambiente</b><br><i>Inox</i>  | EXPO 022     |    | -       | -       | -                         | -                         |
| <b>P 260</b><br><i>Skin plate</i> | RFP 260 0003 |    | 1/6 Hp  | 55 l/h  | 6 l                       | SILVER<br>TC   <b>Ag+</b> |
| <b>P 260</b><br><i>Inox</i>       | RFP 260 0004 |    |         |         |                           |                           |
| <b>P 240</b><br><i>Skin plate</i> | RFP 240 0003 |    | 1/6 Hp+ | 120 l/h | Continuous<br>cold water* | <b>Cu+</b>   <b>HPDC</b>  |
| <b>P 240</b><br><i>Inox</i>       | RFP 240 0004 |    |         |         |                           |                           |
| <b>Pensile 260</b><br><i>Inox</i> | RFPEN 004 01 |    | 1/6 Hp  | 55 l/h  | 6 l                       | SILVER<br>TC   <b>Ag+</b> |

\*(flow <1,5 l/min)

\*\*Disponibile su richiesta con tensioni diverse/Alternative operating voltages available on request.

### Tanto di più senza sovrapprezzo/Plus at no extra charge

- Lavello in acciaio inox/Stainless steel basin
- 2 rubinetti: collo di cigno - zampillo/2 taps: tall spout & bubbler
- Pannello frontale/Front panel
- Sistema HPDC®(High Performance Direct Chill)/HPDC® system (mod. 240)
- Evaporatore in rame antibatterico/Evaporator in antibacterial copper (mod. 240)
- Sistema STC (Silver Turbo Clean) con argento antibatterico/STC system. Uses silver for enhanced antibacterial effect. (mod. 260)
- Camera di refrigerazione pressurizzata in acciaio inox/Pressurised refrigeration chamber in stainless steel (mod. 260)
- Condensazione a ventilazione forzata/Forced ventilation condensation
- Classe energetica A+++/A+++ energy rating (mod. 260)



**Accessori opzionali**  
*Optional accessories*  
PEDALK 010105  
KIT 1 pedale/1 foot control  
(Box+tubi+rubinetti+raccordi+viti)  
(Box+pipes+tap+fittings+screws)

### Schema di installazione/Installation diagram

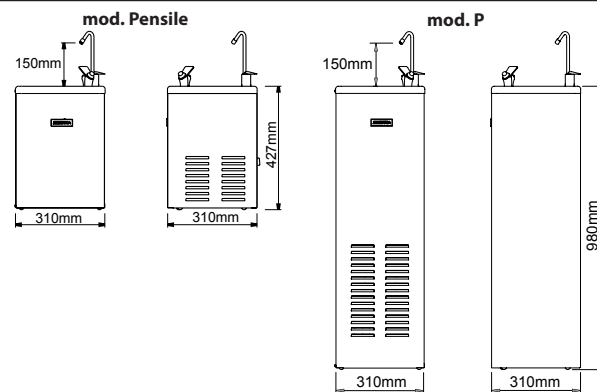
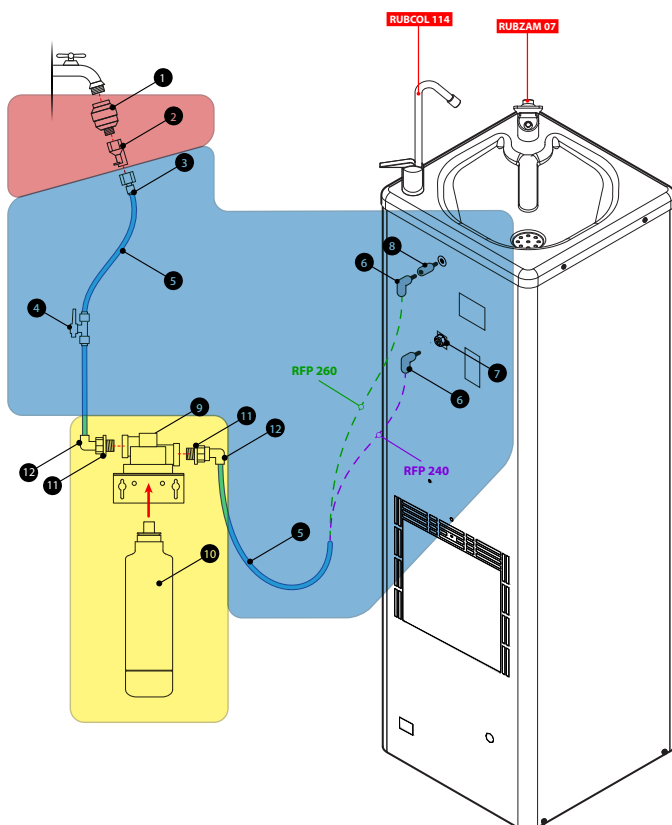

### Completa il tuo ordine/Complete the order

- KIT A** (1-2) Kit di sicurezza  
*Safety kit*
- KIT IST 022** (3...8) Kit installazione  
*Installation kit*
- SIMPLY ONE** (9...12) Kit filtrazione  
*Filtration kit*  
**002 01**
- PROMO 050** Borraccia in alluminio 500 ml  
*Aluminum bottle 500 ml*
- PROMO 051** Borraccia inox termica 550 ml  
*Insulated stainless steel bottle 500 ml*

# POU/POINT OF USE



**In soli 25 cm di larghezza, l'impianto più compatto e completo mai realizzato con l'esclusivo sistema di refrigerazione Silver Turbo Clean.**

*At only 25cm wide, it's compact, but yet has everything in there, including our exclusive Silver Turbo Clean chilling technology.*



CONTACTLESS  
AVAILABLE



PEDALS  
AVAILABLE



Anti Covid-19 solution



*Pedale/Foot control (optional)*

**FUTURA** 40/80/81/90

**"La perfetta quantità di tutto  
Perfection in a small package"**







# Futura 40/80/81/90



10 - 15

| Mod.                              | Cod.          |       | Power   | l/h    | Dispensing | Technology      |
|-----------------------------------|---------------|-------|---------|--------|------------|-----------------|
| <b>40</b><br>Black skin plate     | FTR 040 A0101 | ● ●   |         |        |            |                 |
| <b>40 FT*</b><br>Black skin plate | FTR 040 A0102 | ● ●   |         |        |            |                 |
| <b>80</b><br>Inox                 | FTR 080 A0101 | ● ●   |         |        |            |                 |
| <b>80 FT*</b><br>Inox             | FTR 080 A0102 | ● ●   |         |        |            |                 |
| <b>80 Contactless</b><br>Inox     | FTR 080 A0501 | ● ●   | 1/15 Hp | 25 l/h | 6 l        | SILVER TC   Ag+ |
| <b>81</b><br>Inox                 | FTR 081 A0101 | ● ● ● |         |        |            |                 |
| <b>81</b><br>Inox                 | FTR 081 A0201 | ● ● ● |         |        |            |                 |
| <b>90</b><br>Inox                 | FTR 090 A0101 | ● ● ● |         |        |            |                 |
| <b>90 FT*</b><br>Inox             | FTR 090 A0102 | ● ● ● |         |        |            |                 |
| <b>90 Contactless</b><br>Inox     | FTR 090 A0501 | ● ● ● |         |        |            |                 |

\*Modello compatibile con 2/3 pedali (non inclusi)/Version compliant with 2/3 foot controls (not included)

## Tanto di più senza sovrapprezzo/Plus at no extra charge

- Cabinato in acciaio inox/Stainless steel cabinet (mod. 80-81-90)
- Sistema STC (Silver Turbo Clean) con argento antibatterico/STC system. Uses silver for enhanced antibacterial effect
- Camera di refrigerazione pressurizzata in acciaio inox/Pressurised refrigeration chamber in stainless steel
- Testata + cartuccia filtrante (4000 l - 6 mesi)/Filter head + Cartridge (4000 l - 6 months) (mod. 80-90)
- Testata + cartuccia filtrante (800 l - 12 mesi)/Filter head + Cartridge (800 l - 12 months) (mod. 81 - FTR 081 A0201)
- **RIDCO 006 + RAR 1302**: riduttore CO<sub>2</sub> per bombola monouso/CO<sub>2</sub> reducer for disposable cylinders (mod. 90)
- Vaschetta raccogli gocce collegabile allo scarico/Drip tray with optional connection to drain pipe
- Sistema di controllo tramite LED/LED warning system
- Condensazione con ventole a levitazione magnetica/Magnetic levitation fans (mod. 90)
- Massima silenziosità/Extremely quiet
- Portabicchieri integrato/Integrated cup holder (mod. 80-90)
- Piedini regolabili/Adjustable feet
- Classe energetica A+++/A+++ energy rating

### NOTE:

Futura 40

MOQ 28 pcs. (2 pallets)

Futura 81

MOQ - Contattare l'ufficio commerciale/ MOQ - Please ask our Sales Office.

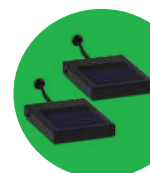

Accessori opzionali  
Optional accessories  
PEDALK 010200  
KIT 2 pedali/2 foot controls

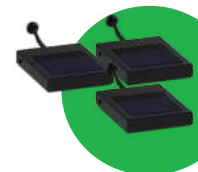

Accessori opzionali  
Optional accessories  
PEDALK 010300  
KIT 3 pedali/3 foot controls

## Schema di installazione/Installation diagram

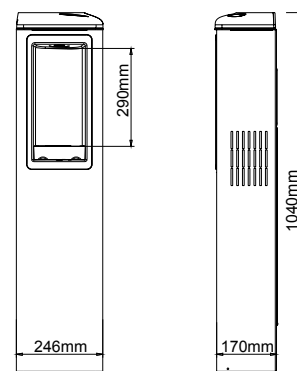
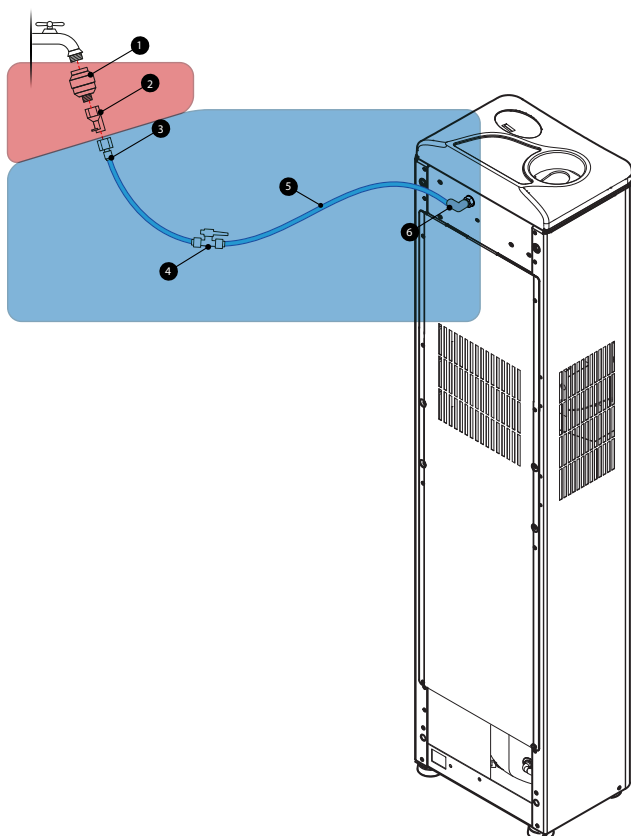

## Completa il tuo ordine/Complete the order

- KIT A** (1-2) Kit di sicurezza Safety kit
- KIT IST 022** (3...6) Kit installazione Installation kit
- BOMB 001** (mod.90) Bombola CO<sub>2</sub> monouso 600 g 600 g disposable CO<sub>2</sub> cylinder
- PROMO 050** Borraccia in alluminio 500 ml Aluminum bottle 500 ml
- PROMO 051** Borraccia inox termica 550 ml Insulated stainless steel bottle 550 ml

**Piccolo, economico e di semplice utilizzo: la soluzione ideale per casa e uffici, con esclusivo sistema di refrigerazione Silver Turbo Clean.**

*Small, easy to use and easy on the budget too. The ideal solution for homes and offices. Uses our exclusive Silver Turbo Clean chilling technology.*



*Pedale/Foot control (optional)*

## AQUAIS 80/90

**“Semplicità a portata di tutti  
Everyday simplicity”**







# Aquaïs 80/90



10 - 15

| Mod.                  | Cod.          |    | Power   | l/h    | Dispensing | Technology         |
|-----------------------|---------------|---|---------|--------|------------|--------------------|
| <b>80</b><br>Inox     | AQS 080 A0101 | ● ●   | 1/15 Hp | 25 l/h | 6 l        | SILVER<br>TC   Ag+ |
| <b>80 FT*</b><br>Inox | AQS 080 A0901 | ● ●   |         |        |            |                    |
| <b>90</b><br>Inox     | AQS 090 A0101 | ● ● ●   |         |        |            |                    |
| <b>90 FT*</b><br>Inox | AQS 090 A0901 | ● ● ●   |         |        |            |                    |

\*Modello compatibile con 2/3 pedali (non inclusi)/Version compliant with 2/3 foot controls (not included)

## Tanto di più senza sovrapprezzo/Plus at no extra charge

- Cabinato in acciaio inox/Stainless steel cabinet
- Sistema STC (Silver Turbo Clean) con argento antibatterico/STC system. Uses silver for enhanced antibacterial effect
- Camera di refrigerazione pressurizzata in acciaio inox/Pressurised refrigeration chamber in stainless steel
- Condensazione con ventole a levitazione magnetica/Magnetic levitation fans
- Massima silenziosità/Extremely quiet
- Banco di ghiaccio privo di riempimento manuale/Maintenance-free ice bank system: no manual filling required
- Raccogli gocce con griglia in acciaio inox/Drip tray with stainless steel grid
- Sistema di controllo tramite LED/LED warning system
- Classe energetica A+++/A+++ energy rating
- Gas ecologico R600a/Eco-friendly R600a gas



### Accessori opzionali

**Optional accessories**  
PEDALK 010201  
KIT 2 pedali (cavo 2 mt)  
2 foot controls (2 m cable)



### Accessori opzionali

**Optional accessories**  
PEDALK 010301  
KIT 3 pedali (cavo 2 mt)  
3 foot controls (2 m cable)

## Schema di installazione/Installation diagram

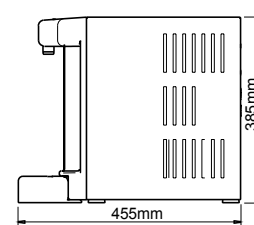
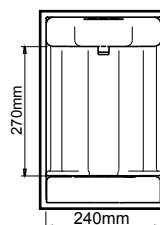
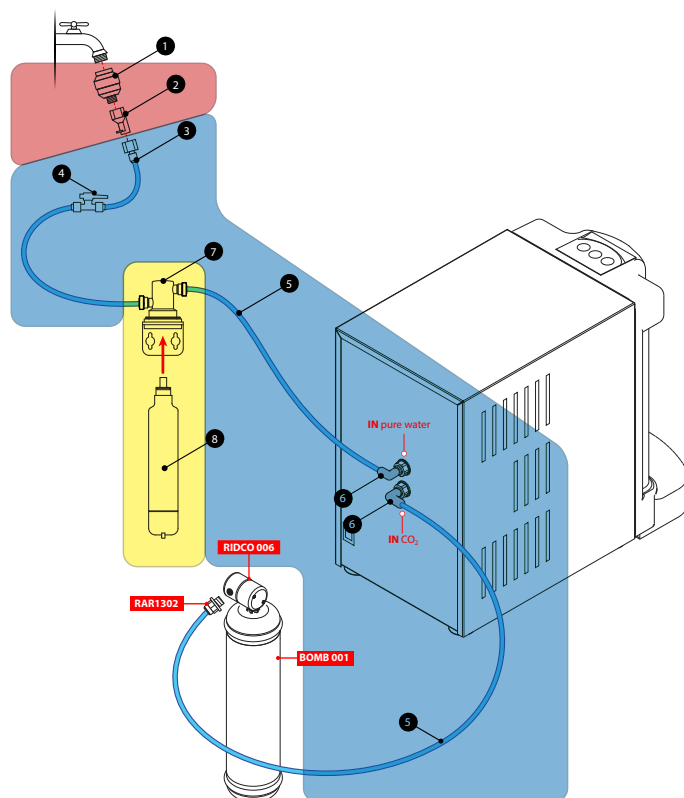

## Completa il tuo ordine/Complete the order

- KIT A** (1-2) Kit di sicurezza Safety kit
- KIT IST 022** (3...6) Kit installazione Installation kit
- SIMPLY ONE 017 04** (7-8) Kit filtrazione Filtration kit
- BOMB 001** (mod.90) Bombola CO<sub>2</sub> monouso 600 g 600 g disposable CO<sub>2</sub> cylinder
- RIDCO 006 + RAR 1302** (mod.90) Riduttore CO<sub>2</sub> per bombola monouso CO<sub>2</sub> reducing valve for disposable cylinder
- PROMO BOTTIGLIA** 6 x bottiglia in vetro 1000 ml 6 x glass bottle 1000 ml

**La soluzione salvaspazio per uso professionale dalle prestazioni sorprendenti con sistema Silver Turbo Clean, anche in versione freestanding.**

*A space saving, hi-spec solutions with exclusive Silver Turbo Clean chilling technology for professional use. Freestanding version also available.*



**TIVOLI 270**

**“Eleganza inossidabile  
Flawless elegance”**





## Tivoli 270



25 - 30

| Mod.        | Cod.            |  | Power  | l/h    | Dispensing | Technology         |
|-------------|-----------------|--|--------|--------|------------|--------------------|
| 270<br>Inox | AQTOP 270 A0101 |  | 1/6 Hp | 50 l/h | 6 l        | SILVER<br>TC   Ag+ |

### Tanto di più senza sovrapprezzo/Plus at no extra charge

- Cabinato in acciaio inox/Stainless steel cabinet
- Sistema STC (Silver Turbo Clean) con argento antibatterico/STC system. Uses silver for enhanced antibacterial effect
- Camera di refrigerazione pressurizzata in acciaio inox/Pressurised refrigeration chamber in stainless steel
- Condensazione con ventole a levitazione magnetica/Magnetic levitation fans
- Massima silenziosità/Extremely quiet
- Banco di ghiaccio privo di riempimento manuale/Maintenance-free ice bank system: no manual filling required
- Raccogliogocce interamente in acciaio inox/Full stainless steel drip tray
- Display LED: controllo manutenzione e cambio filtri/LED display: filter change alert, maintenance alert
- Porzionatura personalizzabile per bicchiere e caraffa/Cup and jug portion settings
- Gas ecologico R600a/Eco-friendly R600a gas



Mobile da pavimento  
Freestanding model  
Cabinato in acciaio inox  
Stainless steel cabinet

### Schema di installazione/Installation diagram

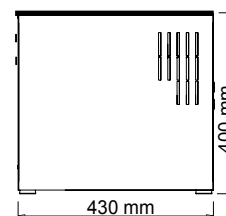
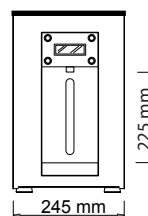
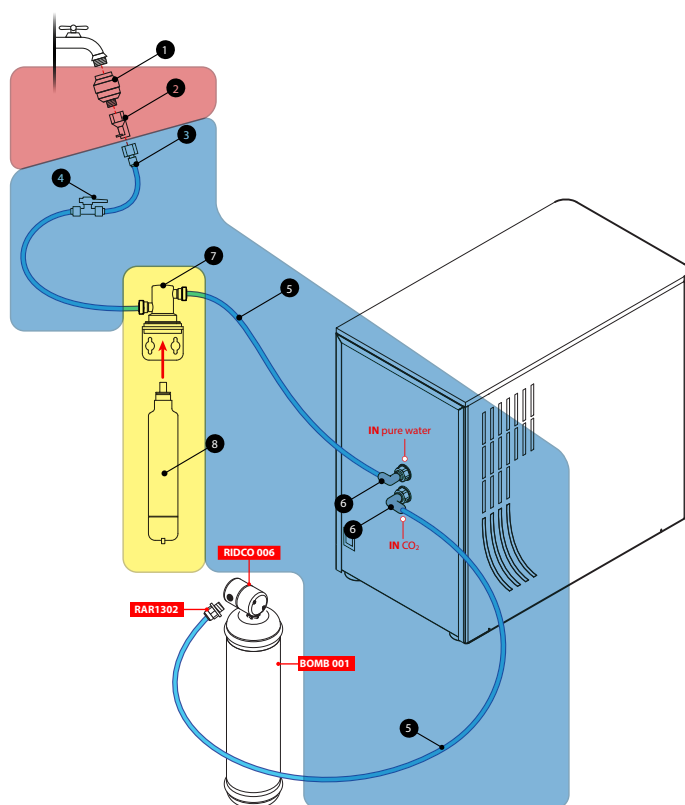

### Completa il tuo ordine/Complete the order

- KIT A** (1-2) Kit di sicurezza  
Safety kit
- KIT IST 022** (3..6) Kit installazione  
Installation kit
- SIMPLY ONE 017 04** (7-8) Kit filtrazione  
Filtration kit
- BOMB 001** Bombola CO<sub>2</sub> monouso 600 g  
600 g disposable CO<sub>2</sub> cylinder
- RIDCO 006 + RAR 1302** Riduttore CO<sub>2</sub> per bombola monouso  
CO<sub>2</sub> reducing valve for disposable cylinder
- PROMO 050** Borraccia in alluminio 500 ml  
Aluminum bottle 500 ml

# SOTTOLAVELLI/UNDERSINK



**Rame e argento: materiali batteriostatici di serie.**  
**Tante soluzioni per casa, ufficio e bar: manutenzioni semplificate e nessuna procedura di riempimento del banco di ghiaccio.**

*Copper and silver antibacterial materials as standard.*  
*Many solution for domestic, office and bar: simplified maintenance and no need for ice bank filling.*



**PERFECT MATCH!**  
(pag. 30)

**Anti Covid-19 solution**

**REFRESH® U 40/80**  
**REFRESH® U 240/260**  
**REFRESH® U 90/150/270**

**“La gamma più completa del reame**  
*A comprehensive undersink range”*





# Refresh® U 40/80



1 - 10

| Mod.       | Cod.          |     | Power   | l/h    | Dispensing | Technology      |
|------------|---------------|-----|---------|--------|------------|-----------------|
| 40<br>Inox | RFU 040 001   | ● ● | 1/15 Hp | 17 l/h | 5 l        | SILVER TC   Ag+ |
| 80<br>Inox | RFU 080 A0601 | ● ● |         | 25 l/h | 6 l        |                 |

## Tanto di più senza sovrapprezzo/Plus at no extra charge

- Cabinato in acciaio inox/Stainless steel cabinet
- Sistema STC (Silver Turbo Clean) con argento antibatterico/STC system. Uses silver for enhanced antibacterial effect
- Camera di refrigerazione pressurizzata in acciaio inox/Pressurised refrigeration chamber in stainless steel
- Massima silenziosità/Extremely quiet
- Banco di ghiaccio privo di riempimento manuale/Maintenance-free ice bank system: no manual filling required
- Condensazione statica/Natural ventilation condensation
- Classe energetica A+++/A+++ energy rating (mod. 80)



6 x bottiglie in vetro  
6 x glass bottles  
1000 ml

Borraccia in alluminio  
Aluminium bottle  
500 ml

Borraccia inox termica  
Insulated stainless steel bottle  
550 ml

**NOTE:**

Refresh U 40

Ordine minimo 100 pezzi. Contattare l'ufficio commerciale/Minimum order quantity 100 units. Please ask our Sales Office.

## Schema di installazione/Installation diagram

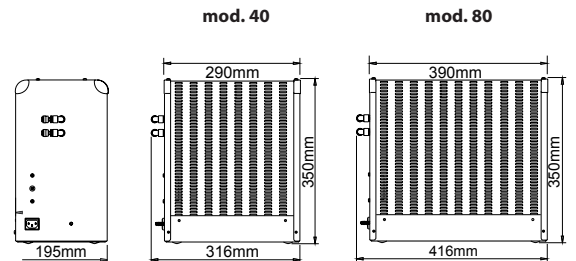
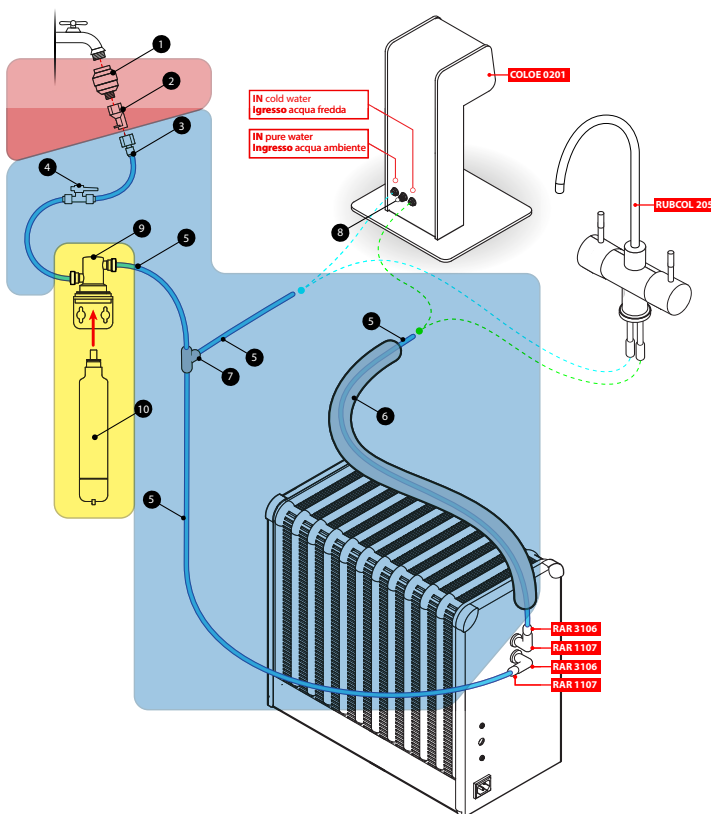

## Completa il tuo ordine/Complete the order

- KIT A** (1-2) Kit di sicurezza Safety kit
- KIT IST 022** (3...8) Kit installazione Installation kit
- SIMPLY ONE 017 04** (9-10) Kit filtrazione Filtration kit
- RUBCOL 121** Rubinetto a 1 via ø 1/4" 1-way column faucet ø 1/4"
- RUBCOL 205 01** Rubinetto a 2 vie ø 1/4" 2-ways column faucet ø 1/4"
- COLOE 0201 OP** Rubinetto professionale plug & play con touchscreen da 5" Professional plug & play tap with 5" touchscreen



# Refresh® U 240/260



20 - 30

| Mod.               | Cod.        |  | Power   | l/h     | Dispensing             | Technology                          |
|--------------------|-------------|---|---------|---------|------------------------|-------------------------------------|
| <b>240</b><br>Inox | RFU 240 001 | ● ●   | 1/6 Hp+ | 110 l/h | Continuous cold water* | <b>Cu<sup>+</sup></b>   <b>HPDC</b> |
| <b>260</b><br>Inox | RFU 260 001 | ● ●   | 1/6 Hp  | 60 l/h  | 6l                     | <b>SILVER TC</b>   <b>Ag+</b>       |

\*(flow <1,5 l/min)

## Tanto di più senza sovrapprezzo/Plus at no extra

- Cabinato in acciaio inox/Stainless steel cabinet
- Sistema HPDC®(High Performance Direct Chill)/HPDC® system (mod. 240)
- Evaporatore in rame antibatterico/Evaporator in antibacterial copper (mod. 240)
- Sistema STC (Silver Turbo Clean) con argento antibatterico/STC system. Uses silver for enhanced antibacterial effect (mod. 260)
- Camera di refrigerazione pressurizzata in acciaio inox/Pressurised refrigeration chamber in stainless steel (mod. 260)
- Banco di ghiaccio privo di riempimento manuale/Maintenance-free ice bank system: no manual filling required (mod. 260)
- Condensazione a ventilazione forzata/Forced ventilation condensation
- Comodo manico per il trasporto/Handle for ease of placement
- Classe energetica A+++/A+++ energy rating (mod. 260)



6 x bottiglie in vetro  
6 x glass bottles  
1000 ml

Borraccia in alluminio  
Aluminium bottle  
500 ml

Borraccia inox termica  
Insulated stainless steel bottle  
550 ml

## Schema di installazione/Installation diagram

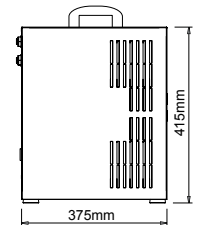
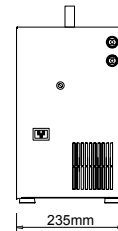
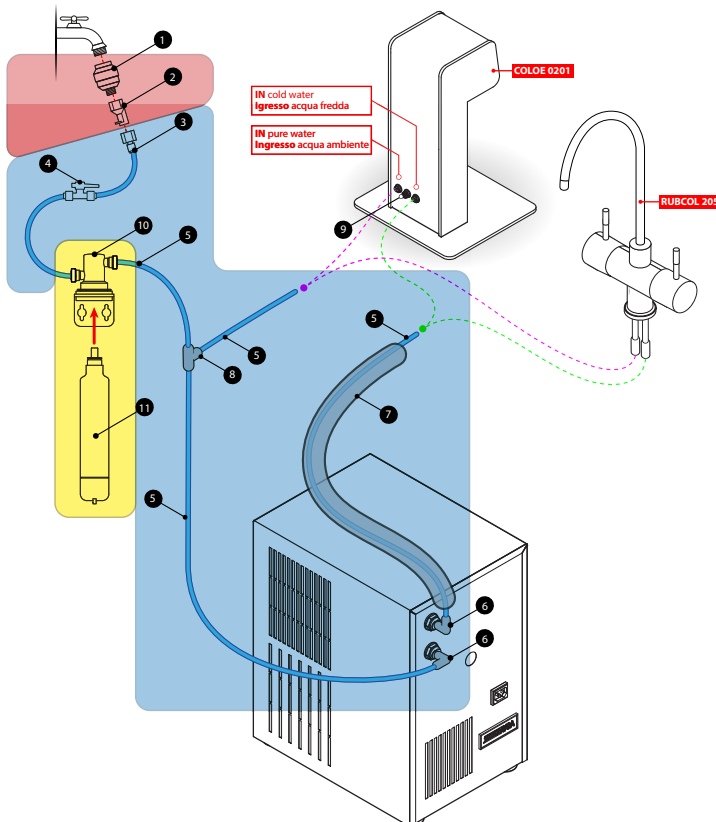

## Completa il tuo ordine/Complete the order

- KIT A** (1-2) Kit antiaggimento  
Safety kit
- KIT IST 022** (3...9) Kit installazione  
Installation kit
- SIMPLY ONE** (10-11) Kit filtrazione  
017 04 Filtration kit
- RUBCOL 121** Rubinetto a 1 via ø 1/4"  
1-way column faucet ø 1/4"
- RUBCOL 205 01** Rubinetto a 2 vie ø 1/4"  
2-ways column faucet ø 1/4"
- COLOE 0201 OP** Rubinetto professionale plug & play con touchscreen da 5"  
Professional plug & play tap with 5" touchscreen





# Refresh® U 90/150/270



| Mod.                     | Cod.          |       | Power   | l/h    | Dispensing | Technology      |
|--------------------------|---------------|-------|---------|--------|------------|-----------------|
| <b>90</b><br>Skin plate  | RFU 090 008   | ● ● ● | 1/10 Hp | 25 l/h | 6 l        | SILVER TC   Ag+ |
| <b>90</b><br>Inox        | RFU 090 004   | ● ● ● |         | 36 l/h |            |                 |
| <b>150</b><br>Skin plate | RFU 150 A0101 | ● ● ● | 1/6 Hp  | 36 l/h | 6 l        | SILVER TC   Ag+ |
| <b>270</b><br>Inox       | RFU 270 004   | ● ● ● |         | 50 l/h |            |                 |

## Tanto di più senza sovrapprezzo/Plus at no extra charge

- Cabinato in acciaio inox/Stainless steel cabinet (mod. 270)
- Sistema STC (Silver Turbo Clean) con argento antibatterico/STC system. Uses silver for enhanced antibacterial effect
- Camera di refrigerazione pressurizzata in acciaio inox/Pressurised refrigeration chamber in stainless steel
- Nessun riempimento manuale della camera di refrigerazione/No manual filling of the refrigeration chamber
- Condensazione con ventole a levitazione magnetica/Magnetic levitation fans
- Massima silenziosità/Extremely quiet
- Classe energetica A+++/A+++ energy rating (mod. 90-150)
- Gas ecologico R600a/Eco-friendly R600a gas (mod. 150)



6 x bottiglie in vetro  
6 x glass bottles  
1000 ml

Borraccia in alluminio  
Aluminium bottle  
500 ml

Borraccia inox termica  
Insulated stainless steel bottle  
550 ml

## Schema di installazione/Installation diagram

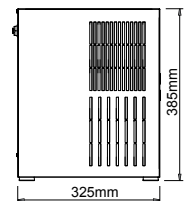
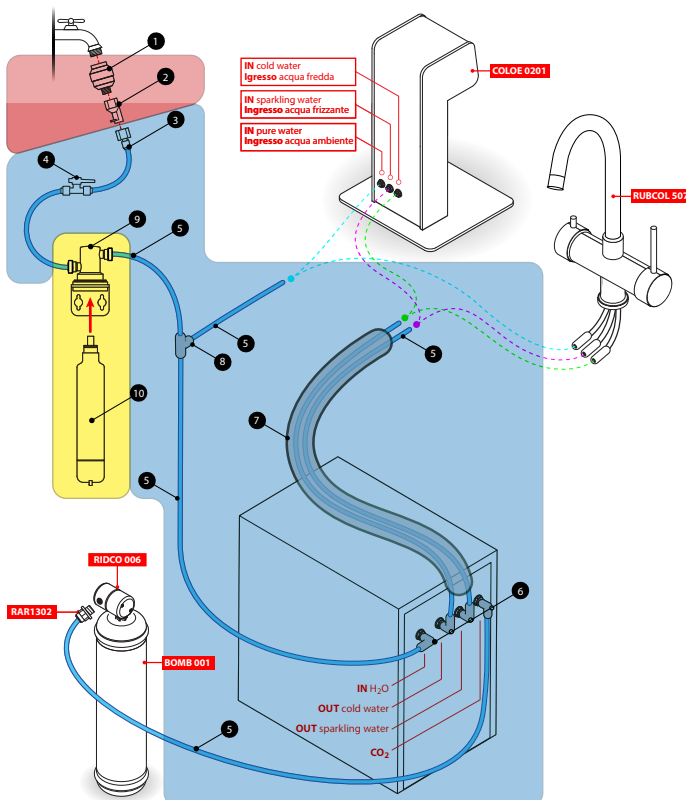

## Completa il tuo ordine/Complete the order

- KIT A** (1-2) Kit di sicurezza Safety kit
- KIT IST 022** (3...8) Kit installazione Installation kit
- SIMPLY ONE 017 04** (9-10) Kit filtrazione Filtration kit
- RUBCOL 205 01** Rubinetto a 2 vie ø 1/4" 2-ways column faucet ø 1/4"
- RUBCOL 507** Rubinetto a 5 vie ø 1/4" 5-ways column faucet ø 1/4"
- COLOE 0201 OP** Rubinetto professionale plug & play con touchscreen da 5" Professional plug & play tap with 5" touchscreen
- BOMB 001** Bombola CO<sub>2</sub> monouso 600 g 600 g disposable CO<sub>2</sub> cylinder
- RIDCO 006 + RAR 1302** Riduttore CO<sub>2</sub> per bombola monouso CO<sub>2</sub> reducing valve for disposable cylinder



**Minimo ingombro, massima praticità di utilizzo.  
Acqua fredda, ambiente, liscia e frizzante in un' unica soluzione.**

*Minimum dimensions, maximum practicality of use.  
Cold, ambient, still and sparkling water in a single solution.*



Anti Covid-19 solution

**I-WALL 150**

**“La soluzione da incasso  
per la tua cucina  
The built-in solution  
for your kitchen”**





## I-Wall 150

| Mod.                      | Cod.          |  | Power   | l/h    | Dispensing | Technology      |
|---------------------------|---------------|--|---------|--------|------------|-----------------|
| <b>150</b><br>Black glass | RFK 150 A0101 |  | 1/10 Hp | 36 l/h | 6 l        | SILVER TC   Ag+ |

### Tanto di più senza sovrapprezzo/Plus at no extra charge

- Pannello in vetro temperato nero/Front panel in black tempered glass
- Sistema STC (Silver Turbo Clean) con argento antibatterico/STC system. Uses silver for enhanced antibacterial effect
- Testata + cartuccia filtrante (4000 l - 6 mesi)/Filter head + Cartridge (4000 l - 6 months)
- **BOMB 001**: bombola CO<sub>2</sub> monouso 600 g/600 g disposable CO<sub>2</sub> cylinder
- **RIDCO 006 + RAR 1302**: riduttore CO<sub>2</sub> per bombola monouso/CO<sub>2</sub> reducer for disposable cylinders
- Area di erogazione illuminata da luce LED/Dispensing area illuminated by LED light
- Esclusivo sistema di telemetria Auxilia/Exclusive Auxilia IoT remote management & telemetry system
- Tablet da 10"/10" touchscreen
- Raccogli gocce con griglia in acciaio inox/Drip tray with stainless steel grid
- Gas ecologico R600a/Eco-friendly R600a gas
- **PROMO BOTTIGLIA**: 2 x bottiglia in vetro 1000 ml/2 x glass bottle 1000 ml



### Schema di installazione/Installation diagram

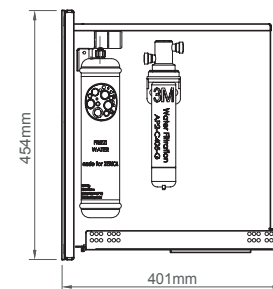
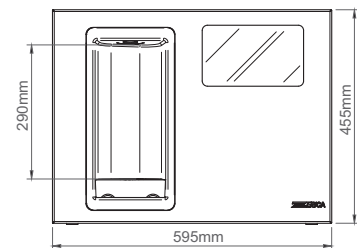
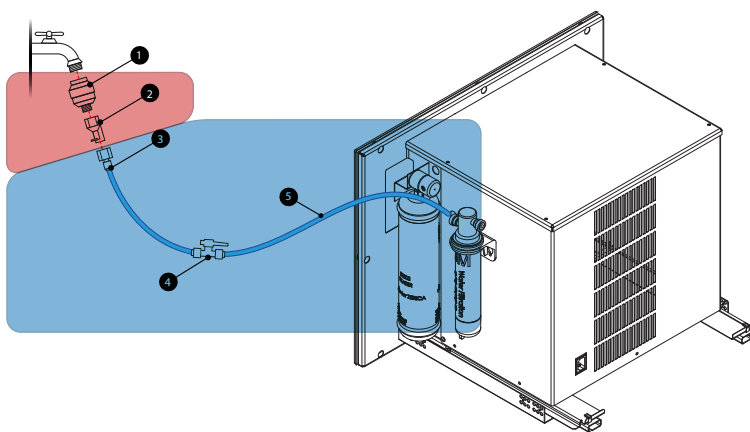

### Completa il tuo ordine/Complete the order

- KIT A** (1-2) Kit di sicurezza  
Safety kit
- KIT IST 022** (3...5) Kit installazione  
Installation kit



**Soluzioni freestanding dal design ergonomico e dalle prestazioni sorprendenti, con comandi touch e tecnologia Auxilia IoT di ultima generazione. Fino a 210 litri in continuo.**

*Self-contained, freestanding, touchscreen units boasting Auxilia, the latest in IoT technologies. Up to 120 L of continuous dispensing.*



## KEMONIA TOUCH 20/100

**“L’impianto all in one più compatto del settore**  
*The most compact self-contained solution in the sector”*













# Kemonia Touch 20/100



100 - 300

| Mod.                     | Cod.          |    | Power  | l/h    | Dispensing | Technology                  |
|--------------------------|---------------|---|--------|--------|------------|-----------------------------|
| <b>20</b><br>Skin plate  | AQA 020 A0301 |    | 1/4 Hp | 60 l/h | 140 l      | ICE BANK<br>DIRECT<br>CHILL |
| <b>100</b><br>Skin plate | AQA 100 A0301 |    | 1/3 Hp | 95 l/h | 210 l      |                             |

## Tanto di più senza sovrapprezzo/Plus at no extra charge

- Cabinato in skin plate antigraffio/Scratchproof skin plate cabinet
- Sistema di gasatura professionale in acciaio inox/Professional-level stainless steel carbonator
- **RIDCO 205 (RIDCO 206 + RAR 2210)**: riduttore 2 quadranti per bombola ricaricabile/ 2 gauge CO<sub>2</sub> reducer for refillable cylinder
- Esclusivo sistema di telemetria Auxilia/Exclusive Auxilia IoT remote management & telemetry system
- Tablet da 5"/5" touchscreen
- Gas ecologico R600a/Eco-friendly R600a gas

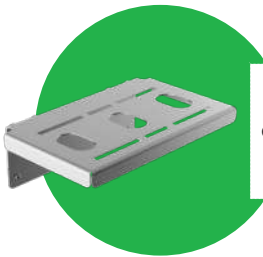

**Accessori opzionali**  
Optional accessories  
Griglia magnetica porta bicchieri  
Cup holders magnetic grid

**6 x bottiglie in vetro**  
6 x glass bottles  
1000 ml

**NOTE:**

Kemonia button

 Ordine minimo 25 pezzi. Contattare l'ufficio commerciale/Minimum order quantity 25 units. Please ask our Sales Office.

### Schema di installazione/Installation diagram

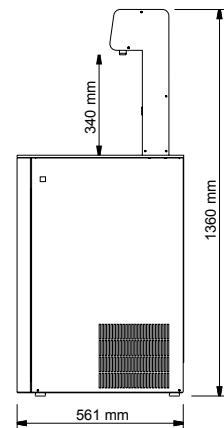
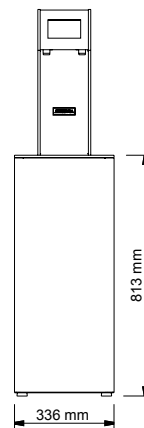
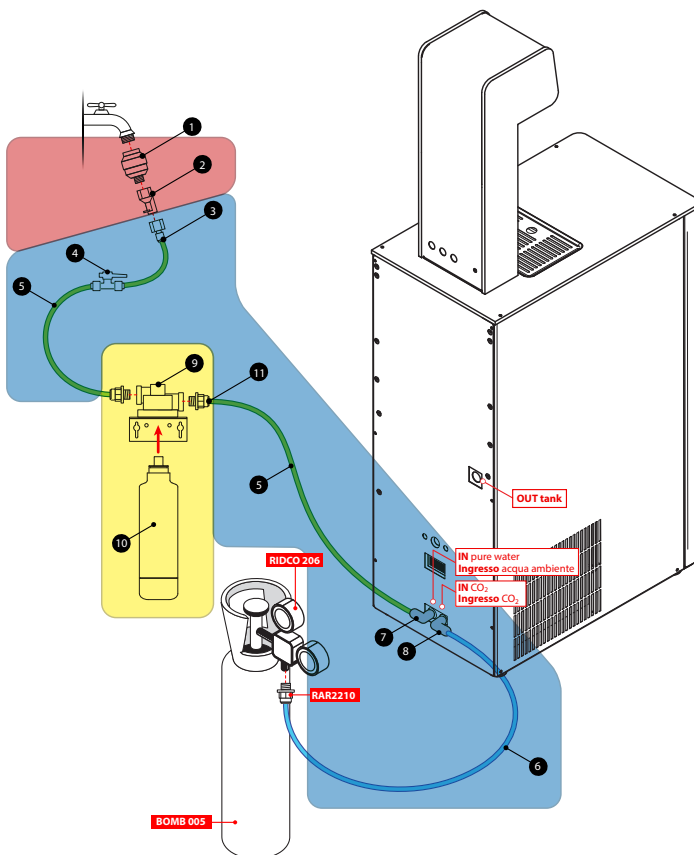

### Completa il tuo ordine/Complete the order

-  **KIT A** (1-2) Kit di sicurezza Safety kit
-  **KIT IST 003** (3...8) Kit installazione Installation kit
-  **SIMPLY ONE** (9...11) **011 01** Kit filtrazione Filtration kit
- BOMB 005** Bombola CO<sub>2</sub> ricaricabile 5 kg 5 kg refillable CO<sub>2</sub> cylinder



**Una gamma di impianti altamente performanti con interfaccia touch e tecnologia Auxilia IoT di ultima generazione compresi nel prezzo. Fino a 210 litri in continuo.**

*A cutting-edge range IoT-enabled (Auxilia), high performing, and touchscreen operated. Up to 120 L of continuous dispensing.*

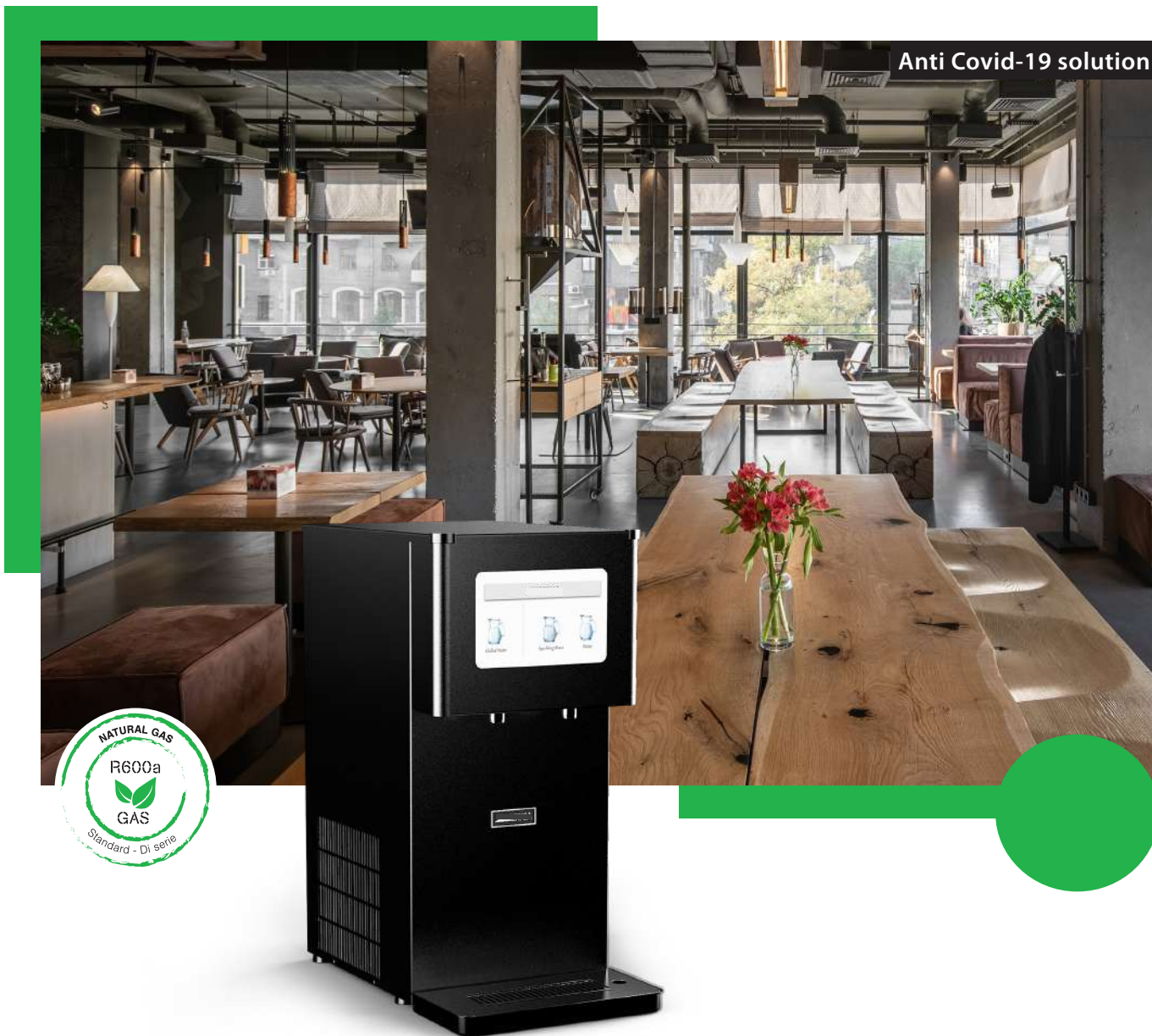

## SIKELIA TOUCH 20/100

**“Il perfetto alleato per il tuo business, in versione sobranbanco  
Your perfect countertop business partner”**





# Sikelia Touch 20/100

100 - 300

| Mod.                     | Cod.           |       | Power  | l/h    | Dispensing | Technology                  |
|--------------------------|----------------|-------|--------|--------|------------|-----------------------------|
| <b>20</b><br>Skin plate  | AQA P020 A0101 | ● ● ● | 1/4 Hp | 60 l/h | 140 l      | ICE BANK<br>DIRECT<br>CHILL |
| <b>100</b><br>Skin plate | AQA P100 A0101 | ● ● ● | 1/3 Hp | 95 l/h | 210 l      |                             |

## Tanto di più senza sovrapprezzo/Plus at no extra charge

- Cabinato in skin plate antigraffio/Scratchproof skin plate cabinet
- Sistema di gasatura professionale in acciaio inox/Professional-level stainless steel carbonator
- **RIDCO 205 (RIDCO 206 + RAR 2210)**: riduttore 2 quadranti per bombola ricaricabile/ 2 gauge CO<sub>2</sub> reducer for refillable cylinder
- Esclusivo sistema di telemetria Auxilia/Exclusive Auxilia IoT remote management & telemetry system
- Tablet da 10"/10" touchscreen
- Raccogliogocce con griglia in acciaio inox/Drip tray with stainless steel grid
- Gas ecologico R600a/Eco-friendly R600a gas

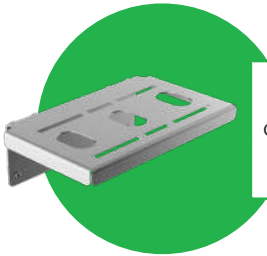

**Accessori opzionali**  
Optional accessories  
Griglia magnetica porta bicchieri  
Cup holders magnetic grid



**6 x bottiglie in vetro**  
6 x glass bottles  
1000 ml

### NOTE:

Sikelia button

Ordine minimo 25 pezzi. Contattare l'ufficio commerciale/Minimum order quantity 25 units. Please ask our Sales Office.

## Schema di installazione/Installation diagram

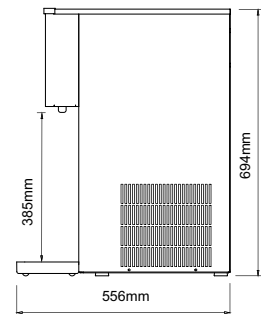
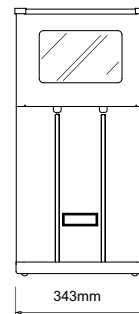
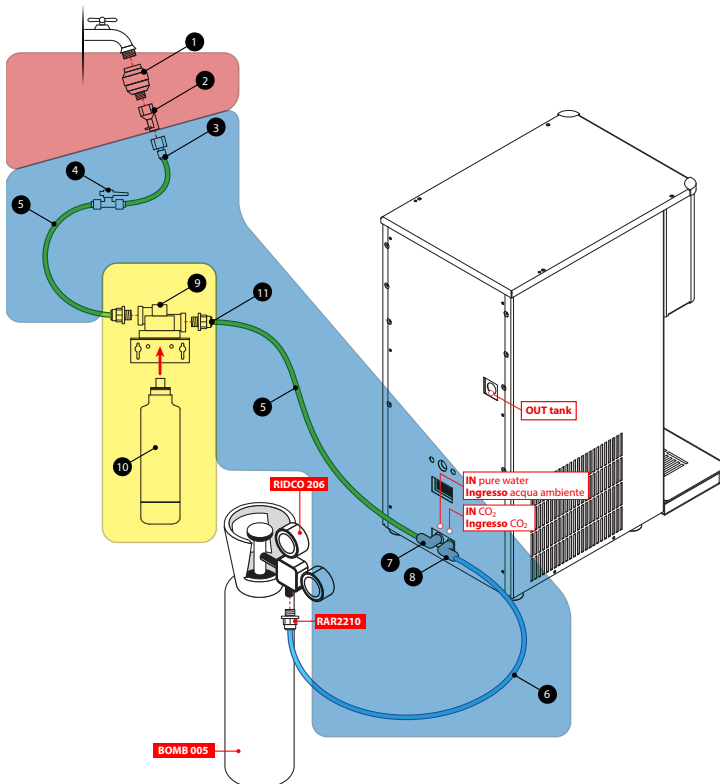

## Completa il tuo ordine/Complete the order

- KIT A** (1-2) Kit di sicurezza  
Safety kit
- KIT IST 003** (3...8) Kit installazione  
Installation kit
- SIMPLY ONE** (9...11) Kit filtrazione  
011 01 Filtration kit
- BOMB 005** Bombola CO<sub>2</sub> ricaricabile 5 kg  
5 kg refillable CO<sub>2</sub> cylinder

**La gamma di refrigeratori più versatile sul mercato. In un unico prodotto, la soluzione sottobanco o sopra banco, con doppio aggancio per rubinetti, per adattarsi a ogni esigenza di utilizzo.**

*The most versatile range on the market. Incredibly adaptable with 3 configurations possible, both undercounter and countertop.*



**PERFECT MATCH!**  
(pag. 30)

**Anti Covid-19 solution**

## REFRESH® BAR C-G 20/32/100

*“Un, due, tre... Refresh® Bar  
Three in one... Refresh® Bar”*







# Refresh® Bar C 20/32/100 - Refresh® Bar G 20/32/100



| Mod.                        | Cod.        |    | Power  | l/h    | Dispensing | Technology                  |
|-----------------------------|-------------|---|--------|--------|------------|-----------------------------|
| <b>C 20</b><br><i>Inox</i>  | RFC 020 001 | ● ●   | 1/6 Hp | 60 l/h | 140 l      | ICE BANK<br>DIRECT<br>CHILL |
| <b>C 32</b><br><i>Inox</i>  | RFC 032 001 | ● ●   | 1/3 Hp | 95 l/h | 170 l      |                             |
| <b>C 100</b><br><i>Inox</i> | RFC 100 001 | ● ●   |        |        | 210 l      |                             |
| <b>G 20</b><br><i>Inox</i>  | RFG 020 001 | ● ● ●   | 1/6 Hp | 60 l/h | 140 l      |                             |
| <b>G 32</b><br><i>Inox</i>  | RFG 032 001 | ● ● ●   | 1/3 Hp | 95 l/h | 170 l      |                             |
| <b>G 100</b><br><i>Inox</i> | RFG 100 002 | ● ● ●   |        |        | 210 l      |                             |

## Tanto di più senza sovrapprezzo/Plus at no extra charge

- Cabinato in acciaio inox/Stainless steel cabinet
- **RIDCO 205 (RIDCO 206 + RAR 2210)**: riduttore 2 quadranti per bombola ricaricabile/ 2 gauge CO<sub>2</sub> reducer for refillable cylinder
- Banco di ghiaccio in acciaio inox/Stainless steel ice bank
- Sistema di ricircolo dell'acqua per installazione sottobanco/Water recirculation system for under counter installations
- Raccogli gocce con griglia in acciaio inox/Drip tray with stainless steel grid
- Piedini regolabili/Adjustable feet



*"Fino a 210 l in continuo"  
"Up to 210 continuous liters"*

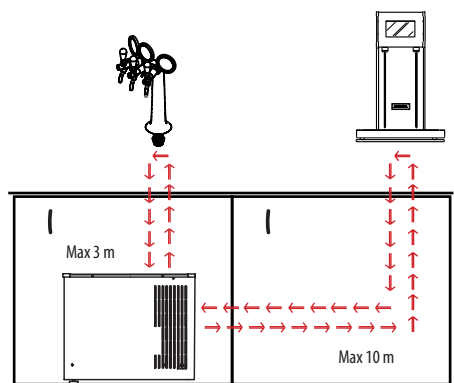

**Sistema di ricircolo dell'acqua**  
Il punto di erogazione può essere installato fino a 10 metri di distanza dal refrigeratore o a 3 metri di dislivello.

**Water recirculation system**  
Dispensing point can be up to 10 meters away from or up to 3 meters above the chiller.

mod. 20

mod. 32-100

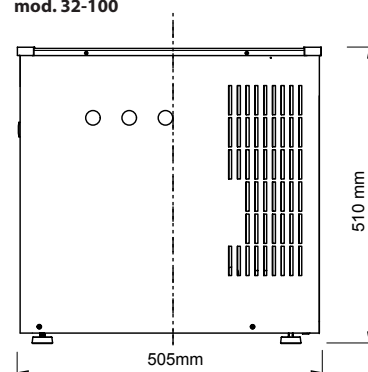
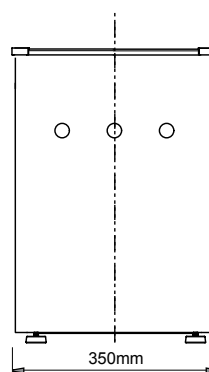
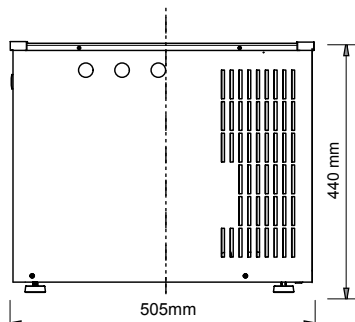
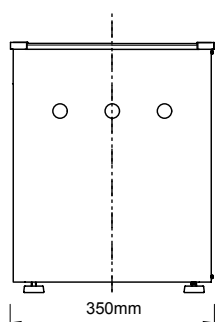



## INSTALLAZIONE SOTTOLAVELLO/UNDERSINK INSTALLATION

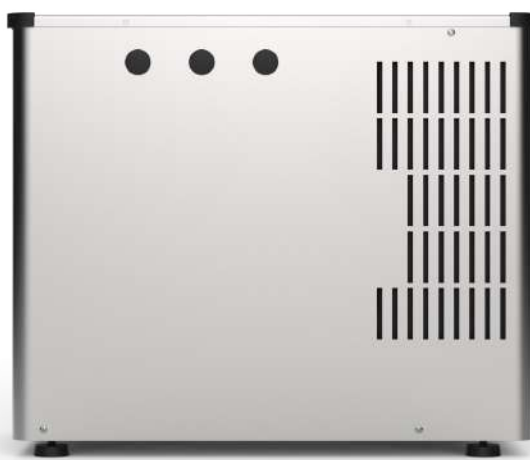

6 x bottiglie in vetro  
6 x glass bottles  
1000 ml

Borraccia in alluminio  
Aluminium bottle  
500 ml

Borraccia inox termica  
Insulated stainless steel bottle  
550 ml

### Schema di installazione/Installation diagram

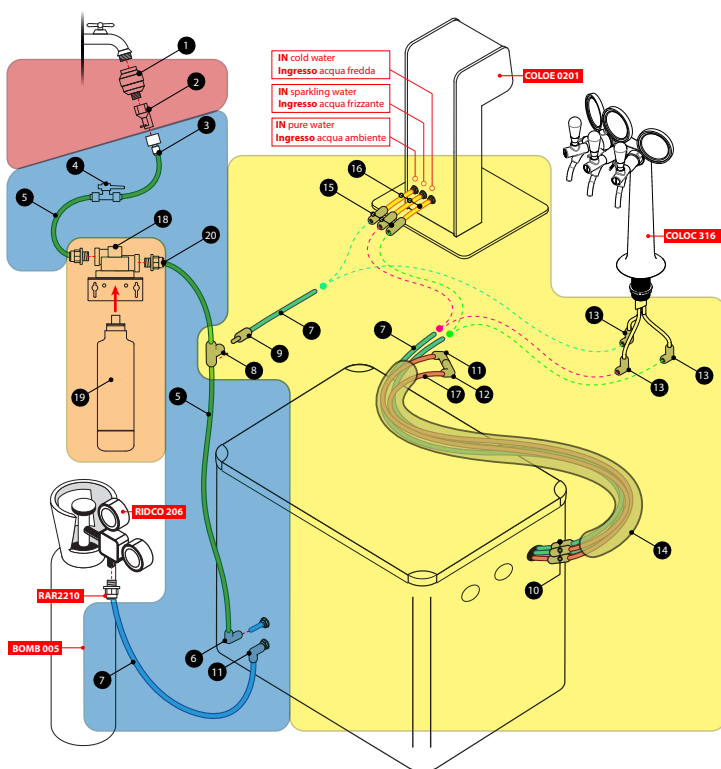

### Completa il tuo ordine/Complete the order

- KIT A** (1-2) Kit di sicurezza  
Safety kit
- KIT IST 003** (3...11) Kit allaccio alla rete idrica  
Main water connection kit
- KIT IST 001** (7-17) Kit installazione colonne  
Column installation kit
- SIMPLY ONE 002 01** (18-20) Kit filtrazione  
Filtration kit
- COLOC 213** Colonna 2 vie rubinetti e medaglioni  
2-way column with taps and medallions
- COLOC 316** Colonna 3 vie rubinetti e medaglioni  
3-way column with taps and medallions
- COLOE 0201 OP** Rubinetto professionale plug & play  
con touchscreen da 5"  
Professional plug & play tap with 5"  
touchscreen
- BOMB 005** Bombola CO<sub>2</sub> ricaricabile 5 kg  
5 kg refillable CO<sub>2</sub> cylinder



## INSTALLAZIONE SOPRALAVELLO/COUNTERTOP INSTALLATION



6 x bottiglie in vetro  
6 x glass bottles  
1000 ml

Borraccia in alluminio  
Aluminium bottle  
500 ml

Borraccia inox termica  
Insulated stainless steel bottle  
550 ml

### Schema di installazione/Installation diagram

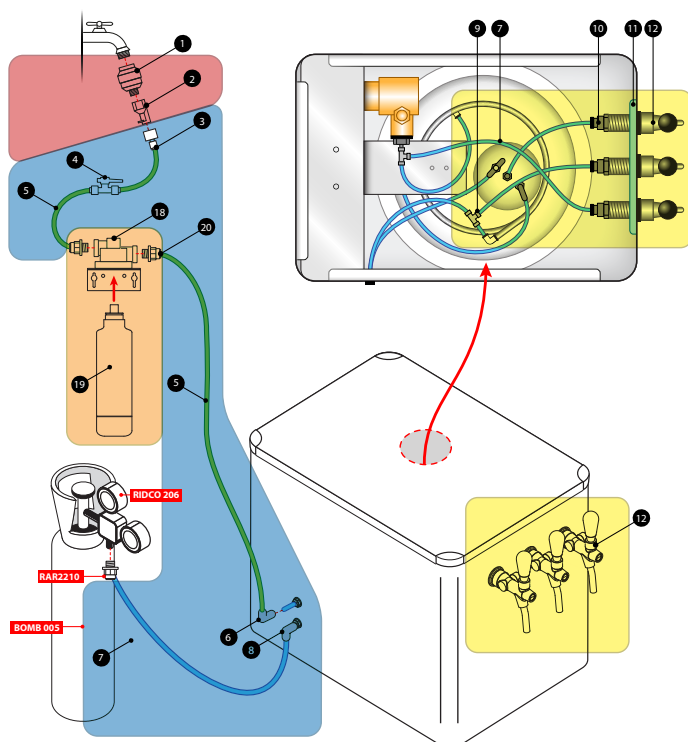

### Completa il tuo ordine/Complete the order

- **KIT A** (1-2) Kit di sicurezza  
Safety kit
- **KIT IST 003** (3...8) Kit allaccio alla rete idrica  
Main water connection kit
- **KIT RFG PLUS 011** (7-12) Kit 3 rubinetti + staffa  
3 taps + bracket kit
- **KIT RFG PLUS 012** (7-12) Kit 2 rubinetti + staffa  
2 taps + bracket kit
- **SIMPLY ONE 002 01** (18-20) Kit filtrazione  
Filtration kit
- BOMB 005** Bombola CO<sub>2</sub> ricaricabile 5 kg  
5 kg refillable CO<sub>2</sub> cylinder

**Impianti altamente performanti anche in condizioni di stress elevato, ideali per chi necessita di grandi quantità di acqua fredda in continuo.**

*High performance levels even in the most stressful environments. Ideal for continuous dispensing of large quantities of cold water.*



**PERFECT MATCH!**  
(pag. 30)

**Anti Covid-19 solution**

**REFRESH® RISTO C-G 135/205**

**“Potenza da scoprire  
Discover the power”**





# Refresh® Risto C-G 135/205



100 - 300

| Mod.                       | Cod.         |       | Power  | l/h     | Dispensing | Technology                  |
|----------------------------|--------------|-------|--------|---------|------------|-----------------------------|
| <b>C 135</b><br>Skin plate | RFC 135 001  | ● ●   | 1/2 Hp | 116 l/h | 507 l      | ICE BANK<br>DIRECT<br>CHILL |
| <b>C 205</b><br>Skin plate | RFC 205 0201 | ● ●   |        | 216 l/h | 663 l      |                             |
| <b>G 135</b><br>Skin plate | RFC 135 002  | ● ● ● |        | 116 l/h | 507 l      |                             |
| <b>G 205</b><br>Skin plate | RFC 205 0301 | ● ● ● |        | 216 l/h | 663 l      |                             |

## Tanto di più senza sovrapprezzo/Plus at no extra charge

• **RIDCO 205 (RIDCO 206 + RAR 2210)**: riduttore 2 quadranti per bombola ricaricabile/ 2 gauge CO<sub>2</sub> reducer for refillable cylinder

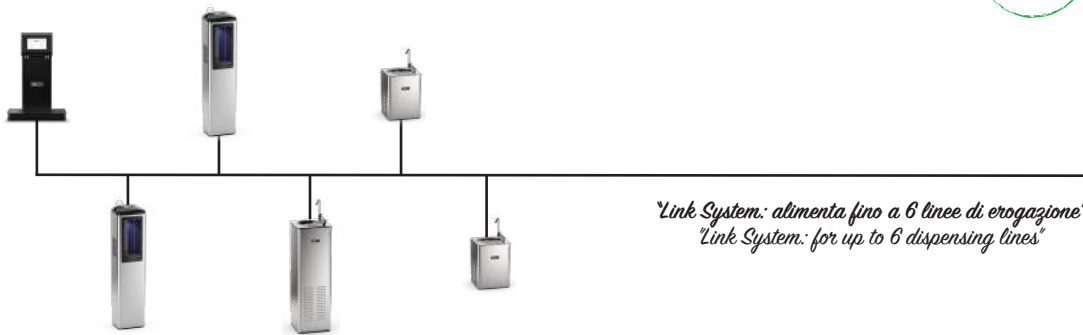

*"Link System: alimenta fino a 6 linee di erogazione"*  
*"Link System: for up to 6 dispensing lines"*



## Schema di installazione/Installation diagram

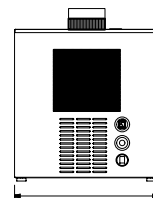
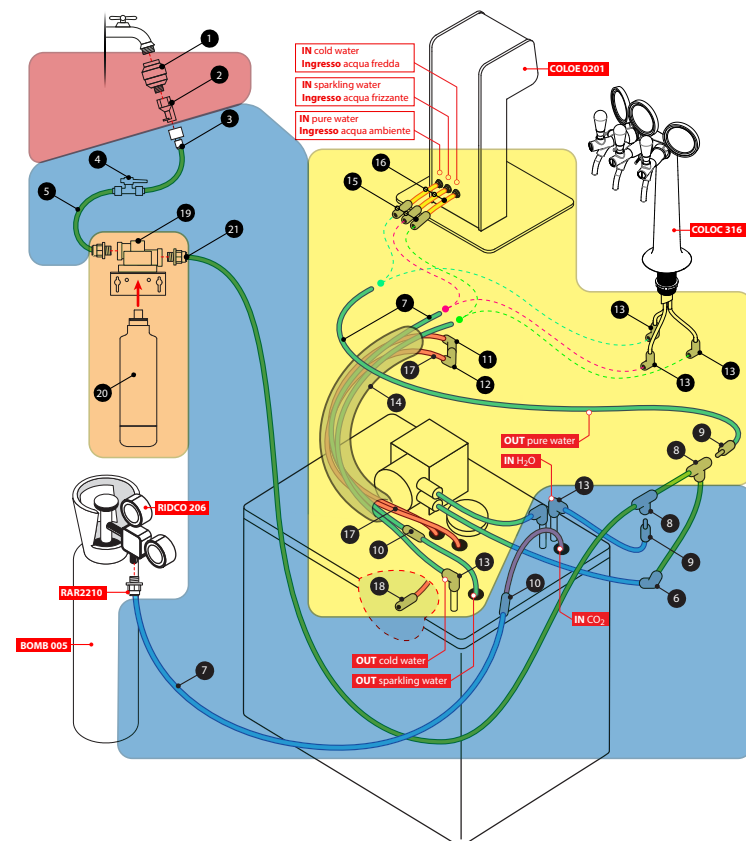

mod. 135: 420 mm  
mod. 205: 517 mm

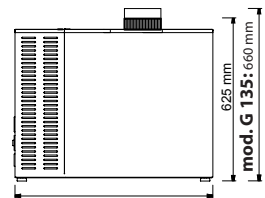

mod. 135: 605 mm  
mod. 205: 745 mm

## Completa il tuo ordine/Complete the order

- KIT A** (1-2) Kit di sicurezza  
Safety kit
- KIT IST 003** (3...13) Kit allaccio alla rete idrica  
Main water connection kit
- KIT IST 001** (7-18) Kit installazione colonne  
Column installation kit
- SIMPLY ONE 002 01** (19-21) Kit filtrazione  
Filtration kit
- COLOC 213** Colonna 2 vie rubinetti e medaglioni  
2-way column with taps and medallions
- COLOC 316** Colonna 3 vie rubinetti e medaglioni  
3-way column with taps and medallions
- COLOE 0201 OP** Rubinetto professionale plug & play con touchscreen da 5"  
Professional plug & play tap with 5" touchscreen
- BOMB 005** Bombola CO<sub>2</sub> ricaricabile 5 kg  
5 kg refillable CO<sub>2</sub> cylinder
- PROMO BOTTIGLIA** 6 x bottiglia in vetro 1000 ml  
6 x glass bottle 1000 ml

# KOLUMNA TOUCH



**La prima colonna di erogazione che non richiede la foratura del piano di lavoro.**  
**Display touch e tecnologia IoT Auxilia di ultima generazione: infinite soluzioni per il tuo business.**

*Professional, ultra-slim touchscreen 'tap' dispensing unit with the latest in IoT technologies.*  
*With easy plug and play, no-drilling option.*



Anti Covid-19 solution

**“Il rubinetto è diventato SMART**  
*One SMART dispensing unit!”*





## Kolumna Touch

| Mod.                             | Cod.          |
|----------------------------------|---------------|
| Touch<br><i>Skin plate</i>       | COLOE 0201    |
| Touch combo<br><i>Skin plate</i> | COLOE 0201 OP |

### Tanto di più senza sovrapprezzo/Plus at no extra charge

- Esclusivo sistema di telemetria Auxilia/*Exclusive Auxilia IoT remote management & telemetry system*
- Tablet da 5"/5" *touchscreen*
- Raccogliocce con griglia in acciaio inox/*Drip tray with stainless steel grid*
- **PROMO BOTTIGLIA:** 2 x bottiglia in vetro 1000 ml/*2x glass bottle 1000 ml*



#### NOTE:

##### Kolumna button

📦 Ordine minimo 50 pezzi. Contattare l'ufficio commerciale/*Minimum order quantity 50 units. Please ask our Sales Office.*

##### \*Touch combo

Prezzo speciale se abbinato a RFU/BAR/RISTO/*Discounted price when bought with RFU/BAR/RISTO.*

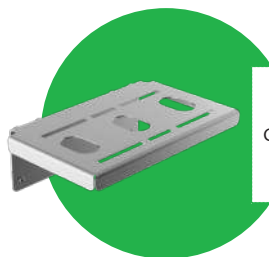

#### Accessori opzionali *Optional accessories*

Griglia magnetica porta bicchieri  
*Cup holders magnetic grid*

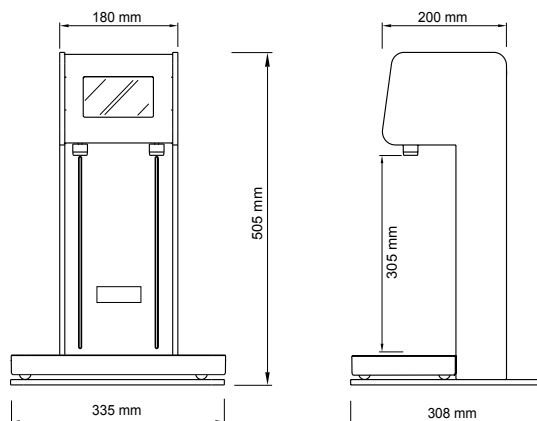

#### DOPPIA EROGAZIONE

Acqua fredda, liscia e frizzante o fredda, liscia e ambiente

*DUAL DISPENSING*

*Chilled still and sparkling water, or still and ambient options*



#### AMPIO RACCOLLIGOCCE

Per riporre comodamente bottiglie e carafes

*SPACIOUS DRIP TRAY*

*Easily accommodates bottles & carafes*



#### RIPOSIZIONAMENTO SEMPLIFICATO

Non occorrono ulteriori procedure di installazione

*Easy repositioning*















---

**Ricambi e accessori**  
**Parts and accessories**

## FILTRAZIONE/FILTRATION

|   | Code              | Description  | Note                       | Qty                   |   |  |
|---|-------------------|--|----------------------------|-----------------------|---|--|
|    | TESTA<br>002      | Testata EVERPURE<br>EVERPURE head  | 3/8" F                     | 1                     |   |  |
|    | CARCBA<br>002     | Cartuccia EVERPURE PRE-COAT 4C<br>Cartridge EVERPURE PRE-COAT 4C                           | 11.300 L<br>12 months      | 1                     |   |  |
|   |                   |  |                            | 12                    |   |  |
|   |                   |  |                            | 120                   |   |  |
|    | CARCBA<br>003     | Cartuccia EVERPURE PRE-COAT AC<br>Cartridge EVERPURE PRE-COAT AC                           | 2.840 L<br>12 months       | 1                     |   |  |
|   |                   |  |                            | 12                    |   |  |
|   |                   |  |                            | 120                   |   |  |
|    | CARCBA<br>003 01  | Cartuccia AC vuota per sanificazione<br>Empty AC cartridge for sanitization                | Riutilizzabile<br>Reusable | 1                     |   |  |
|   | CARCBA<br>011     | Cartuccia EVERPURE PRE-COAT MC<br>EVERPURE PRE-COAT MC cartridge                           | 34.000 L<br>12 months      |                       |   |  |
|  | TESTA<br>017      | Testata 3M<br>3M head  | Ø 1/4" - by-pass           | 1                     |   |  |
|  | CARCBA<br>017     | Cartuccia 3M - 0,5 micron carboni attivi<br>Cartridge 3M - 0,5 micron carbon block         | 4.000 L<br>6 months        | 1                     |   |  |
|   |                   |  |                            | 10                    |   |  |
|   |                   |  |                            | 25                    |   |  |
|   |                   |  |                            | 50                    |   |  |
|   |                   |  |                            | 100                   |   |  |
|  | CARCBA<br>017 01  | 3M - 0,5 micron carboni attivi (anticalcare)<br>3M - 0,5 micron carbon block (antiscalare) | 4.000 L<br>6 months        | 1                     |   |  |
|  | CARCBA<br>017 90  | 3M vuota per sanificazione<br>Empty 3M for sanitization                                    | Riutilizzabile<br>Reusable | 1                     |   |  |
|  | TESTA<br>020 G3/8 | Testata BWT<br>BWT head  | 3/8" M                     | 1                     |   |  |
|  | CARCBA<br>020 01  | BWT BESTMAX; Riduce Ca2+ (anticalcare)<br>BWT BESTMAX; For Ca2+ reduction (antiscalare)    | 3100 L<br>12 months        | 1                     |   |  |
|   | CARCBA<br>020 02  |  |                            | 10.690 L<br>12 months | 1 |  |
|   | CARCBA<br>020 03  |  |                            | 800 L<br>12 months    | 1 |  |



## RUBINETTI/TAPS

|   | Code             | Description  | Note   | Qty |  |
|---|------------------|--|--|-----|--|
|    | RUBCOL<br>105    | Rubinetto 1 via - pulsante<br><i>1 way glass filler - push button</i>  | H 255 mm<br>3/8" F                               |     |  |
|    | RUBCOL<br>121    | Rubinetto ECO 1 via - miscelatore<br><i>1 way ECO tap - mixer</i>  |  |     |  |
|    | RUBCOL<br>205 01 | Rubinetto ECO 2 vie - miscelatore<br><i>2 ways ECO tap - mixer</i>   |  |     |  |
|   | RUBCOL<br>310    | Rubinetto LEV 3 vie - pomelli<br><i>3 ways tap - knobs</i>   | Ø 1/4"   | 1   |  |
|  | RUBCOL<br>507    | Rubinetto ECO 5 vie - 2 miscelatori<br><i>5 ways ECO tap - 2 mixers</i>                                      | Ø 6 mm o 1/4"                                    | 1   |  |
|  | RUBCOL<br>117    | Rubinetto 1 via - levetta<br><i>1 way glass filler - black tap lever</i>                                     | H 190 mm<br>codolo/shank 1/4"<br>dado/nut 3/8" F | 1   |  |
|   | RUBCOL<br>114    |  | H 190 mm<br>OUT Ø 8 mm                           |     |  |
|  | RUBZAM<br>012    | Rubinetto a zampillo con regolazione laterale<br><i>Push button bubbler with side regulator</i>              | codolo/shank 1/4"<br>dado/nut 3/8" F             |     |  |
|   | RUBZAM<br>07     |  | codolo/shank 1/4"<br>dado/nut 3/8" F<br>Ø 8 mm   |     |  |
|  | RUBBIC<br>02     | Rubinetto con compensatore<br><i>Tap with compensator</i>  | 5/8" - 3/8" F<br>for BAR                         |     |  |
|   | RUBBIC<br>05     |  | 5/8"<br>for COLOC                                |     |  |
|  | COLOC<br>213     | Colonna 2 vie con rubinetti, medaglioni e adesivi<br><i>2 ways column with taps, medallions and stickers</i> |  |     |  |
|  | COLOC<br>316     | Colonna 3 vie con rubinetti, medaglioni e adesivi<br><i>3 ways column with taps, medallions and stickers</i> |  |     |  |

## ACCESSORI PER CO<sub>2</sub>/CO<sub>2</sub> ACCESSORIES

|   | Code           | Description   | Note  | Qty |
|---|----------------|---|---|-----|
|    | RIDCO<br>002   | Riduttore CO <sub>2</sub> per BOMB 001<br><i>CO<sub>2</sub> reducer for BOMB 001</i>  | IN 11x1<br>OUT 1/8" F                           | 1   |
|    | RIDCO<br>006   | Riduttore CO <sub>2</sub> per BOMB 001<br><i>CO<sub>2</sub> reducer for BOMB 001</i>  | IN 11x1<br>OUT 1/8" F                           | 1   |
|    | RIDCO<br>102   | Riduttore CO <sub>2</sub> 1 manometro per BOMB 001<br><i>1 manometer CO<sub>2</sub> reducer for BOMB 001</i>  | IN 11x1<br>OUT 1/8" F                           | 1   |
|   | RIDCO<br>103   |   | IN 11x1<br>OUT Ø1/4" F<br>filetto/thread 1/8" M |     |
|    | RIDCO<br>104   | Riduttore CO <sub>2</sub> 1 manometro per BOMB 002<br><i>1 manometer CO<sub>2</sub> reducer for BOMB 002</i>  | IN W21,7<br>filetto/thread 1/8" F               | 1   |
|   | RIDCO<br>105   |   | IN W21,7<br>OUT Ø1/4" F                         |     |
|   | RIDCO<br>205   | Riduttore CO <sub>2</sub> 2 manometri per BOMB 005<br><i>2 manometers CO<sub>2</sub> reducer for BOMB 005</i>   | IN W21,7<br>OUT Ø8 F<br>filetto/thread 1/4" M   | 1   |
|   | RIDCO<br>206   |   | IN W21,7<br>OUT 1/4" F                          |     |
|  | BOMB<br>001    | Bombola CO <sub>2</sub> monouso<br><i>CO<sub>2</sub> disposable cylinder</i>  | filetto/thread<br>M 11 x 1<br><br>0,6 Kg        |     |
|  | BOMB<br>005    | Bombola CO <sub>2</sub> ricaricabile<br><i>Refillable CO<sub>2</sub> cylinder</i>   |   |     |
|  | PIST SL<br>001 | Pistola per il seltz "cigno"- in ottone cromato<br>completa di tubo flessibile<br><i>"Swan" soda gun - in chromed brass<br/>complete with flexible tube</i> | tubo a 1/4"<br><i>1/4" tube</i>                 |     |



# KIT

|   | Code              | Description  | Compatibility  | Qty                   |                       |
|---|-------------------|--|--|-----------------------|-----------------------|
|    | KIT AQS 010       | Testata - riduttore - staffa - raccorderie montaggio retro<br><i>Head - reducer - bracket - fittings for rear mounting</i>                   | Aquais 090   |                       |                       |
|    | KIT IST 001       | Kit collegamento a COLOC/COLOE<br><i>Connection kit to COLOC/COLOE</i>   | Bar Risto  |                       |                       |
|    | KIT IST 003       | Kit collegamento alla rete idrica<br><i>Main water connection kit</i>  | Kemonia<br>Sikelia<br>Bar Risto                        | 1                     |                       |
|    | KIT IST 022       | Kit impianto idrico<br><i>Water fittings kit</i>   | Refresh® U<br>Refresh® P<br>Futura<br>Aquais<br>Tivoli | 1                     |                       |
|    | KIT RFG PLUS 011  | Kit soprabanco 3 rubinetti<br><i>Counter-top kit with 3 taps</i>   | Bar  |                       |                       |
|    | KIT RFG PLUS 012  | Kit soprabanco 2 rubinetti<br><i>Counter-top kit with 2 taps</i>   | Bar  |                       |                       |
|   | SIMPLY ONE 002 01 | Impianto di filtrazione completo di cartuccia e testata Everpure 4C<br><i>Filtration system with cartridge and 4C Everpure head</i>          | Refresh® P<br>Bar Risto                                | 1                     |                       |
|  | SIMPLY ONE 011 01 | Impianto di filtrazione completo di cartuccia e testata Everpure MC<br><i>Filtration system with cartridge and MC Everpure head</i>          | Kemonia<br>Sikelia                                     | 1                     |                       |
|  | SIMPLY ONE 017 04 | Impianto di filtrazione completo di cartuccia e testata 3M<br><i>Filtration system with cartridge and 3M Everpure head</i>                   | Aquais<br>Tivoli<br>Refresh® U                         | 1                     |                       |
|  | SIMPLY DUAL 001   | Sistema di filtrazione: sedimenti + carbone attivo + sterilizzatore UV<br><i>Water filtration system: sediments + carbon + UV sterilizer</i> | All products   |                       |                       |
|  | PEDALK 010200     | Kit 2 pedali<br><i>Kit 2 foot controls</i>   | Cavo/Cable 10 cm                                       | 14-99<br>>100         |                       |
|  | PEDALK 010201     |  | Cavo/Cable 2 mt  | 1-13<br>14-99<br>>100 |                       |
|  | PEDALK 010300     |  | Cavo/Cable 10 cm                                       | 1-13<br>14-99<br>>100 |                       |
|  | PEDALK 010301     |  | Kit 3 pedali<br><i>Kit 3 foot controls</i>             | Cavo/Cable 2 mt       | 1-13<br>14-99<br>>100 |

## ACCESSORI & MERCHANDISING/ACCESSORIES & MERCHANDISING

|   | Code               | Description   | Note   | Qty |  |
|---|--------------------|---|--|-----|--|
|    | WATERST<br>004     | Blocco di sicurezza - calibrato a 10 litri<br><i>Safety block - pre-calibrated for 10 litres</i>  | IN Ø 3/4" F<br>OUT 1/4" F                                      | 1   |  |
|    | WATERST<br>004 RST | Reset esterno per WATERST 004<br><i>External reset for WATERST 004</i>  | IN Ø 3/4" F<br>OUT 1/4" F                                      |     |  |
|    | TUBO<br>420 01     | Tubo polietilene<br><i>Polyethylene pipe</i>  |  |     |  |
|   | TUBO<br>431 01     |   |  |     |  |
|    | CONTALT<br>002     | Contaltri elettronico<br><i>Electronic flow meters</i>  |  |     |  |
|    | POMPAB<br>100      | Kit pompaggio idrico da boccione<br><i>Booster Pump kit for bottled connection</i>  |  |     |  |
|   | MOBIL<br>005       | Mobile acciaio inox con serratura<br><i>Stainless steel cabinet with lock</i>   | <i>H x W x D (cm)</i><br>88 x 24 x 45<br><br><i>for Tivoli</i> |     |  |
|  | RACGO<br>002       | Raccogliocce in acciaio inox<br><i>Stainless steel driptray</i>   | <i>H x W x D (mm)</i><br>27 x 275 x 133                        |     |  |
|  | RACGO<br>023 01    | Raccogliocce professionale in ABS nero<br>completo di griglia in acciaio inox<br><i>Professional drip tray in ABS<br/>with stainless steel grid</i> | <i>H x W x D (mm)</i><br>30 x 335 x 160                        | 1   |  |
|  | SL GRIGL<br>010    | Griglia magnetica poggia bicchieri<br>regolabile in altezza<br><i>Magnetic grid for cups<br/>adjustable in height</i>                               | <i>H x W x D (mm)</i><br>65 x 180 x 118                        | 1   |  |
|  | SANIT<br>001       | Igienizzante a base alcolica<br><i>Alcoholic sanitizer</i>  | 300 ml   | 12  |  |

## LOGISTICA/LOGISTICS

|                             | <br>cm (h x w x d) | <br>cm (h x w x d) | <br>Kg |  | <br>cm (h x w x d) |
|-----------------------------|---|---|---|---|---|
| <b>Refresh® PENSILE</b>     | 49 x 31 x 31  | 71 x 37 x 37  | 17  | 12  | 143 x 80 x 120  |
| <b>Refresh® P 260</b>       | 98 x 31 x 31  | 110 x 37,5 x 33   | 26  | 6   | 127 x 80 x 120  |
| <b>Refresh® P 240</b>       | 98 x 31 x 31  | 110 x 37,5 x 33   | 26  | 6   | 127 x 80 x 120  |
| <b>FUTURA 40</b>            | 104 x 24,6 x 17   | 109 x 27,6 x 20   | 16  | 14  | 127 x 80 x 120  |
| <b>FUTURA 80</b>            | 104 x 24,6 x 17   | 109 x 27,6 x 20   | 16  | 14  | 127 x 80 x 120  |
| <b>FUTURA 81</b>            | 104 x 24,6 x 17   | 109 x 27,6 x 20   | 19  | 14  | 127 x 80 x 120  |
| <b>FUTURA 90</b>            | 104 x 24,6 x 17   | 109 x 27,6 x 20   | 20  | 14  | 127 x 80 x 120  |
| <b>AQUAIS 80</b>            | 38,5 x 24 x 47  | 49 x 27 x 53  | 17  | 18  | 160 x 80 x 120  |
| <b>AQUAIS 90</b>            | 38,5 x 24 x 47  | 49 x 27 x 53  | 19  | 18  | 160 x 80 x 120  |
| <b>TIVOLI 270</b>           | 39 x 24,5 x 43  | 49 x 27 x 53  | 26  | 18  | 160 x 80 x 120  |
| <b>Refresh® U 40</b>        | 35 x 19,5 x 29  | 48,5 x 24 x 42  | 10,5  | 21  | 160 x 80 x 120  |
| <b>Refresh® U 80</b>        | 35 x 19,5 x 39  | 48,5 x 26 x 52  | 11,4  | 18  | 160 x 80 x 120  |
| <b>Refresh® U 240</b>       | 37,5 x 23,5 x 41,5  | 48,5 x 26 x 52  | 17  | 18  | 160 x 80 x 120  |
| <b>Refresh® U 260</b>       | 37,5 x 23,5 x 41,5  | 48,5 x 26 x 52  | 17  | 18  | 160 x 80 x 120  |
| <b>Refresh® U 90</b>        | 38,5 x 24 x 32,5  | 49 x 27 x 53  | 20  | 18  | 160 x 80 x 120  |
| <b>Refresh® U 150</b>       | 38,5 x 24 x 32,5  | 49 x 27 x 53  | 20  | 18  | 160 x 80 x 120  |
| <b>Refresh® U 270</b>       | 38,5 x 24 x 32,5  | 49 x 27 x 53  | 20  | 18  | 160 x 80 x 120  |
| <b>Refresh® BAR C 20</b>    | 44 x 33,5 x 50,5  | 53 x 38 x 59  | 32  | 8   | 120 x 80 x 120  |
| <b>Refresh® BAR C 32</b>    | 51 x 33,5 x 50,5  | 61 x 38,5 x 59  | 40  | 8   | 135 x 80 x 120  |
| <b>Refresh® BAR C 100</b>   | 51 x 33,5 x 50,5  | 61 x 38,5 x 59  | 40  | 8   | 135 x 80 x 120  |
| <b>Refresh® BAR G 20</b>    | 44 x 33,5 x 50,5  | 53 x 38 x 59  | 32  | 8   | 120 x 80 x 120  |
| <b>Refresh® BAR G 32</b>    | 51 x 33,5 x 50,5  | 61 x 38,5 x 59  | 40  | 8   | 135 x 80 x 120  |
| <b>Refresh® BAR G 100</b>   | 51 x 33,5 x 50,5  | 61 x 38,5 x 59  | 40  | 8   | 135 x 80 x 120  |
| <b>Refresh® RISTO C 135</b> | 62,5 x 42 x 60,5  | 73 x 48 x 70  | 37  | 2   | 80 x 120 x 80   |
| <b>Refresh® RISTO C 205</b> | 62,5 x 51,7 x 74,5  | 77 x 56 x 80  | 50  | 2   | 90 x 80 x 120   |
| <b>Refresh® RISTO G 135</b> | 66 x 42 x 60,5  | 73 x 48 x 70  | 37  | 2   | 80 x 120 x 80   |
| <b>Refresh® RISTO G 205</b> | 66 x 51,7 x 74,5  | 77 x 56 x 80  | 50  | 2   | 90 x 80 x 120   |
| <b>Kemonia 20</b>           | 136 x 33,6 x 56,1   | 144 x 39 x 60   | 38  | 4   | 159 x 80 x 120  |
| <b>Kemonia 100</b>          | 136 x 33,6 x 56,1   | 144 x 39 x 60   | 48  | 4   | 159 x 80 x 120  |
| <b>Sikelia 20</b>           | 69,4 x 34,3 x 55,6  | 81 x 39 x 53  | 32  | 4   | 96 x 80 x 120   |
| <b>Sikelia 100</b>          | 69,4 x 34,3 x 55,6  | 81 x 39 x 53  | 40  | 4   | 96 x 80 x 120   |
| <b>Kolumna</b>              | 50,5 x 33,5 x 30,8  | 35 x 60 x 40  | 15  | 16  | 160 x 80 x 120  |
| <b>I-Wall</b>               | 45,5 x 59,5 x 46  | 51 x 66 x 56  | 31  | 2   | 70 x 80 x 120   |

## TERMINI DI GARANZIA/WARRANTY TERMS

DSCPUMPS garantisce che al momento dell'acquisto i suoi prodotti sono esenti da eventuali difetti dei materiali e di fabbricazione.

La garanzia è valida in condizioni d'utilizzo conformi ai manuali tecnici e alle specifiche di DSCPUMPS per un periodo di 12 mesi a partire dalla data di acquisto originaria (data emissione fattura).

La presente garanzia non si applica alle parti soggette ad usura e al normale logorio, ai consumabili, ai relativi elementi di sostituzione o a qualsivoglia utilizzo non contemplato nella gamma delle specifiche come definita nel manuale di istruzioni per l'installazione, l'uso e la manutenzione.

La garanzia è limitata alla sostituzione delle parti difettose o riparazione presso lo stabilimento DSCPUMPS e non comprende in nessun caso la sostituzione integrale del prodotto difettoso né il rimborso dello stesso o dei costi sostenuti dal rivenditore per eventuali interventi.

I prodotti restituiti per la riparazione e le parti difettose dovranno essere inviate a DSCPUMPS in porto franco previa autorizzazione al reso mediante invio di apposito modulo RMA.

DSCPUMPS provvederà franco destino alla restituzione del prodotto riparato o all'invio di parti di ricambio.

Per maggiori informazioni: [sales@dscpumps.it](mailto:sales@dscpumps.it)

*DSCPUMPS guarantees that its products does not have any material, design or manufacture defect when purchasing.*

*The warranty is valid when product is properly operating under normal condition of use in accordance with technical manuals and DSCPUMPS specifications and for a period of 12 months from date of purchase (invoice date).*

*The warranty does not cover the replacement of parts due to normal wear and tear, consumable parts, related replacement parts or any abuse or misuse, including but not solely limited to the failure to use this product for its normal purposes or in accordance with DSCPUMPS's instructions on installation, usage and maintenance.*

*The warranty is limited to the replacement or repair of faulty parts at DSCPUMPS factory and it does not cover in no event the entire replacement of the faulty product or the reimbursement of costs incurred by the reseller for any intervention.*

*All products being returned for repair and faulty parts shall be shipped to DSCPUMPS with freight prepaid after requesting the return authorization by means of the appropriate RMA request form.*

*DSCPUMPS will return the repaired product or the spare parts with transportation charges prepaid.*

*More information here: [sales@dscpumps.it](mailto:sales@dscpumps.it)*





**DSCPUMPS SRL**  
DOSING FILTER AND STORAGE

**DSCPUMPS srl**

Via Magenta,87  
Busto Arsizio  
21052 (VA)

P.Iva 03452650124  
[www.dscpumps.it](http://www.dscpumps.it)

**DSCPUMPS**